

OD4015-12HB

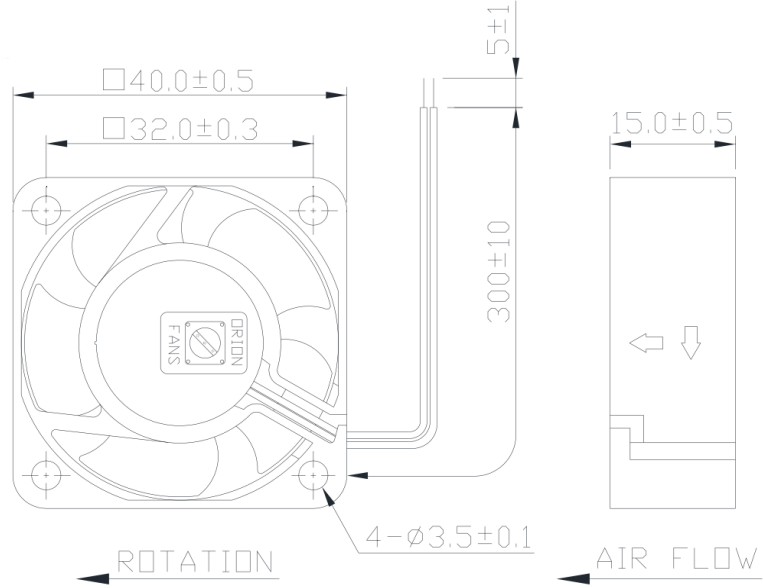

DC Fan, 12VDC
40x15mm (1.58x.59in)



Frame & Impeller	PBT, UL94V-0 plastic	Available Options IP55 Other speeds and voltages Tachometer Alarm	<p>Static Pressure mmH₂O inH₂O 3066</p> <p>6.232 24528 4.674 18396 3.116 12264 1.558 06132 0</p> <p>0 2 4 6 8 10 cfm 0 0604 1208 1812 2416 m³/min</p>
Connection	2x Lead wires *		
Motor	Brushless DC, auto restart, polarity protected.		
Bearing System	Dual ball bearing		
Insulation Resistance	Min. 10M at 500VDC	*Connection: Wire Leads - UL1007 26AWG Red(+), Black (-),	
Dielectric Strength	1 second at 500VAC max leakage 500 microamp	Weight: 24 g	
Temperature Range	-10C ~ +70C		
Storage Temperature	-40C ~ +80C		
Life (L10)	70,000 hours (40C)		

Model Number	OD4015-12HB
Part Number	146141001
Nominal Voltage	12 VDC
Voltage Range	9 ~ 13.2 VDC
Nominal Current	.11 A
Rated Power	1.8 Watts
Rated Speed (RPM)	8000
Airflow (CFM)	8.5
Noise Level (dB)	36
Max. Static Pressure	.25 "H ₂ O

